

Product description

Designed to provide optimum high quality downlight, Black incorporates the unique ToD technology in its extreme compact structures to avoid any possible spill light for perfect light control. Multi-functional lighting solutions include fixed, adjustable and wallwasher, together with three dimming methods, all are suitable for new creative freedom in numerous indoor lighting applications.

Product features

- High quality, extreme compact frame made of aluminium ensures excellent heat dissipation
- Light aperture: $\Phi 25\text{mm}$
- Incorporated unique ToD optic system reduce direct glare significantly
- High visual comfort
- High power LED
- Cutout: 28mm
- On-off/DALI/Wireless versions available
- DALI versions occupy 1 address
Wireless versions occupy 1 address

- Frame – matt white/matt black
Reflector – specular silver/black/gold

Technical data

Input	DC24V
Power consumption	3W
CRI	>90
CCT	3000K
Beam angle	34°
Chromaticity tolerance	<3 SDCM
Rated lifetime	50000H (Ta 25°C)
Dimming method	On-off or DALI/Wireless
Dimming range	On-off or 0-100%

Luminous intensity distribution curve

LED 2W 193lm 3000K

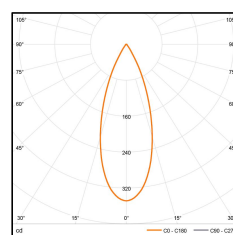

H(m)	D(m)	E(lx)
1.0	0.62	324
2.0	1.24	81
3.0	1.86	36
4.0	2.48	20
5.0	3.10	13

Power Supply Info

Type	Dimming	Art. No.	Input	Output	Power	Address	QTY
Constant Current Driver	On-off	M9102102.001	AC220V	700mA	Max.15W	—	5-6
	On-off	M9102102.002	AC220V	700mA	Max.25W	—	9-10
	On-off	M9102102.003	AC220V	700mA	Max.40W	—	10-19
	DALI	M9102102.004	AC220V	700mA	Max.17W	1	5-8
	DALI	M9102102.005	AC220V	700mA	Max.25W	1	7-11
	DALI	M9102102.006	AC220V	700mA	Max.45W	1	9-16
	Wireless	M9102102.007	AC220V	700mA	Max.19W	1	4-8
Constant Voltage Power Supply	—	M9102103.001	AC220V	DC24V	Max.18W	—	Max.4
	—	M9102103.003	AC220V	DC24V	Max.40W	—	Max.10
	—	M9102103.005	AC220V	DC24V	Max.60W	—	Max.16
DC-DC Driver	On-off	M9102102.009	DC24V	700mA	—	—	1
	DALI	M9102102.010	DC24V	700mA	—	1	1
	Wireless	M9102102.011	DC24V	700mA	—	1	1



M9102101.001
Reflector
Specular silver

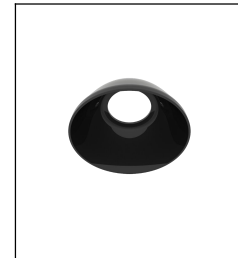

M9102101.002
Reflector
Specular black

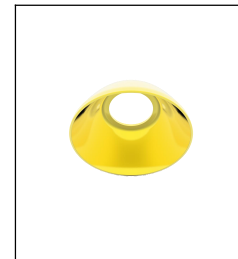

M9102101.006
Reflector
Specular gold

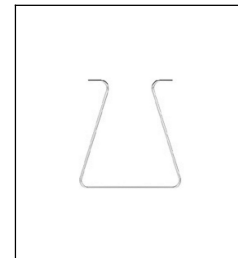

M9102101.003
Mechanical hook

CC(Constant Current Driver) wiring diagram

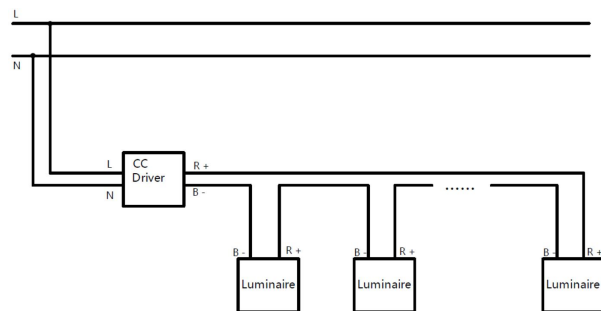

DO NOT inter-connect wires with different colors.
Please consider the **TOTAL ADDRESSES** before wiring

CV(Constant Voltage Power Supply) wiring diagram

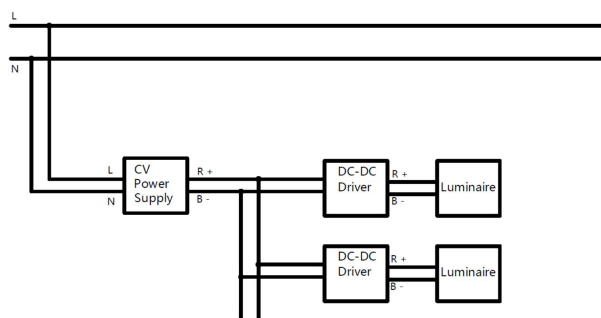

DO NOT inter-connect wires with different colors.
Please consider the **TOTAL ADDRESSES** before wiring

Wiring diagrams are examples of typical installations intended to illustrate the number of luminaire that must be connected. These diagrams are not intended to specify all equipment necessary for a given circuit.

Please confirm all details with LiteMatrix or suppliers before wiring so as to avoid any unnecessary damage.